

REV.	ECN NO.	DESCRIPTION	DRAW	APPD.	DATE
A	---				

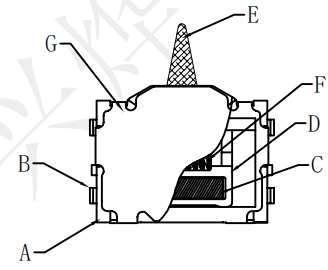

PCB板位置尺寸

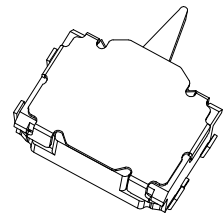
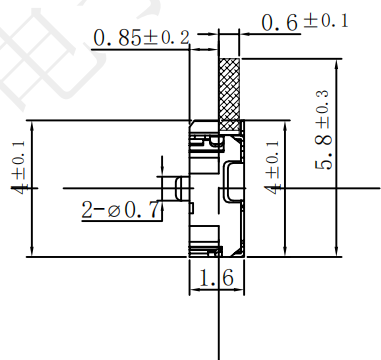
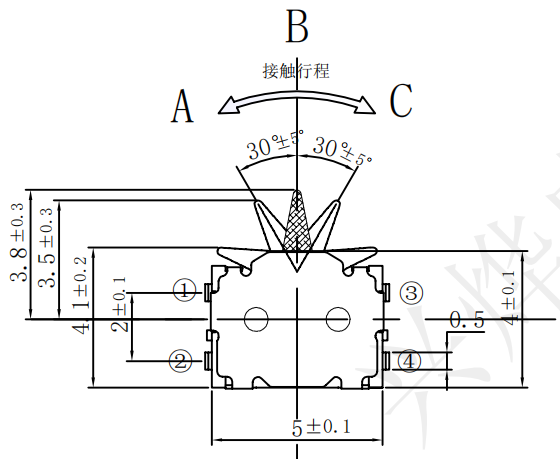
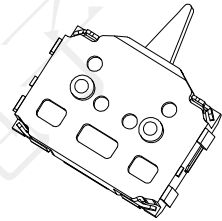
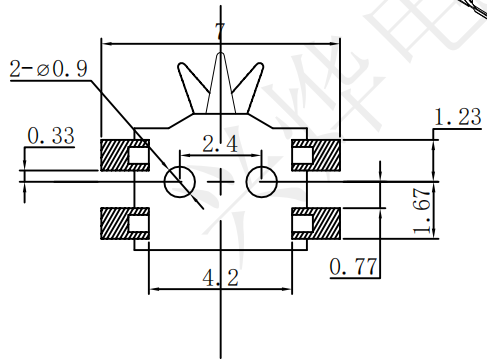
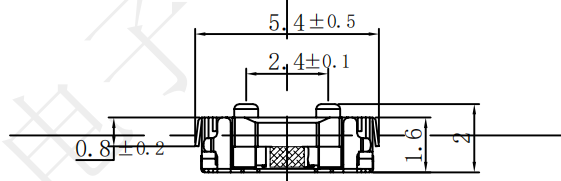

SPECIFICATION:
 Operating temperature: -10 °C~60 °C
 Rated loading: DC 12V 0.5A
 Contact resistance: 500mΩ Max
 Insulation resistance: 100MΩ Min
 Withstanding voltage: AC100V(50/60Hz) /min
 Operating force: 30±20gf Max
 Electrical Life: 50000 cycles

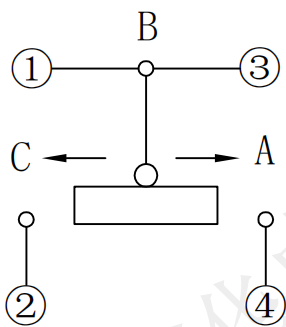

电路原理图

受控文件

CODE TABLE (<input checked="" type="checkbox"/> ON)			
ANGLE	85°	0°	85°
TERMINAL	C	B	A
①	(30°)		(30°)
②			
③			
④			

序号	名称	数量	材料	镀涂 颜色
G	盖 子	1	不锈钢	银白色
F	弹 簧	1	不锈钢	银白色
E	按 键	1	增强尼龙	黑 色
D	推 钮	1	增强尼龙	黑 色
C	接 触 弹 簧	1	磷 铜	银白色镀银
B	卡 件	1	磷 铜	黑色与镀银
A	底 座	1	P P A	黑 色

深圳市兴烨电子有限公司
 Shenzhen XingYe Electronics co., Ltd

TOLERANCE		APPD: 陈爱光
XX ±0.30	X° ±2°	CHED: 施立敏
.XX ±0.20	X° ±1°	
.XXX ±0.10	XX° ±0.5°	
UNITS	mm	DRAW: 马洪飞

Series Name :		
Product Description :	检测开关XY-C31U	
Part No:	AKL20018	
SCALE	SHEET	REV.
1:1	1/1	A1